

Line Regulator Controller

Features

- Low Dropout Voltage: 100mV @ 650mA with FZT749 PNP Transistor
- 2.7V to 8V Supply Range
- Low Operating Current: 50µA Operating, 0.2µA Shutdown
- Low True Chip Enable
- Output Accuracy $\lt; \pm 2\%$
- Small Package: 5-Pin SOT-23A

Applications

- Battery Operated Systems
- Portable Instruments
- High-Efficiency Linear Regulator
- Post-Regulator for SMPS
- Power Supply or Battery Back-Up Supply for Memory

Device Selection Table

Part Number	Output Voltage	Package	Temperature Range
TC572502ECT	2.5V	5-Pin SOT-23A	-40°C to +85°C
TC573002ECT	3.0V	5-Pin SOT-23A	-40°C to +85°C
TC573302ECT	3.3V	5-Pin SOT-23A	-40°C to +85°C

Other output voltages and package options are available. Please contact Microchip Technology Inc. for details.

Package Type

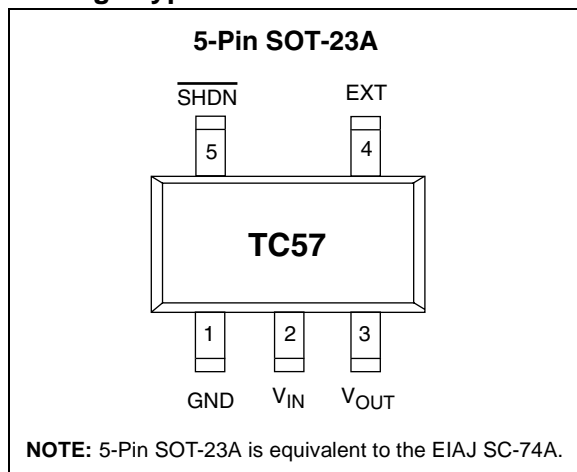

General Description

The TC57 is a low dropout regulator controller that operates with an external PNP pass transistor, allowing the user to tailor the LDO characteristics to suit the application at hand. This results in lower dropout operation (and often lower cost) compared with traditional linear regulators with on-board pass transistors. The maximum output current of a TC57-based regulator circuit is limited only by the characteristics of the external pass transistor. For example, a maximum output current of 650mA (with a dropout voltage of 100mV) results when an FZT749 pass transistor is used, while a Darlington configuration can deliver up to 4A.

Flexibility, and superior performance make this family of regulator controllers the ideal choice in applications where low dropout voltage and low installed cost are key.

Functional Block Diagram

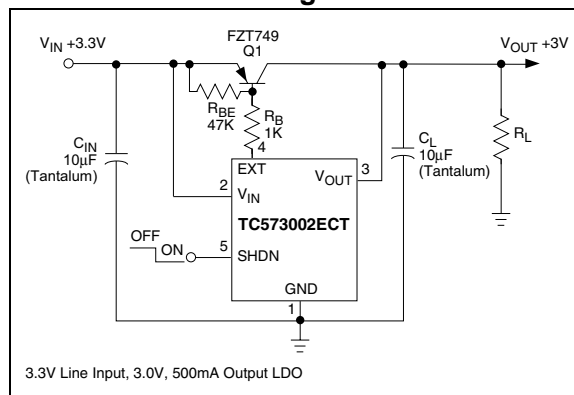

TC57

1.0 ELECTRICAL CHARACTERISTICS

Absolute Maximum Ratings*

Input Voltage	+12V
Output Current	50mA
Output Voltage.....	-0.3V to (V _{IN} + 0.3V)
Power Dissipation.....	150mW
Operating Temperature Range.....	-40°C to +85°C
Storage Temperature Range	-40°C to +150°C

*Stresses above those listed under "Absolute Maximum Ratings" may cause permanent damage to the device. These are stress ratings only and functional operation of the device at these or any other conditions above those indicated in the operation sections of the specifications is not implied. Exposure to Absolute Maximum Rating conditions for extended periods may affect device reliability.

TC55 ELECTRICAL SPECIFICATIONS

TC57EP3002 Electrical Characteristics: $\overline{\text{SHDN}} = \text{GND}$, $V_{\text{IN}} = V_{\text{OUT}} + 1\text{V}$, $V_{\text{OUT}} = 3\text{V to } 5\text{V}$, $I_{\text{OUT}} = 0$, $T_{\text{A}} = 25^{\circ}\text{C}$, Test Circuit of Figure 3-1, unless otherwise noted. (Note 2)						
Symbol	Parameter	Min	Typ	Max	Units	Test Conditions
V _{IN}	Input Voltage	—	—	8	V	
V _{EXT}	Voltage on EXT Output	—	—	8	V	
V _{OUT}	Output Voltage	0.98 × V _R	V _R ±0.5%	1.02 × V _R	V	I _{OUT} = 50mA (Note 1)
ΔV _{OUT}	Load Regulation	-60	—	60	mV	1mA ≤ I _{OUT} ≤ 100mA (Note 3)
V _{IN} - V _{OUT}	Dropout Voltage	—	100	—	mV	I _{OUT} = 100mA (Note 2)
I _{DD}	Supply Current	—	50	80	μA	$\overline{\text{VSHDN}} = V_{\text{IN}} = 5\text{V}$
I _{SHDN}	Shutdown Supply Current	—	—	0.6	μA	$\overline{\text{VSHDN}} = \text{GND}$
ΔV _{OUT} /ΔV _{IN}	Line Regulation	—	0.1	0.3	%/V	I _{OUT} = 50mA, 4V ≤ V _{IN} ≤ 8V (Note 3)
ΔV _{OUT} /ΔT	V _{OUT} Temperature Coefficient	—	±100	—	ppm/°C	I _{OUT} = 10mA, -40°C < T _J < +85°C (Note 3)
I _{LEXT}	EXT Pin Leakage Current	—	—	0.5	μA	
I _{EXT}	EXT Sink Current	—	—	25	mA	Note 4
V _{IH}	SHDN Input High Logic Threshold	1.5	—	—	V	
V _{IL}	SHDN Input Low Logic Threshold	—	—	0.25	V	
I _{IH}	SHDN Input Current @ V _{IH}	—	—	0.1	μA	$\overline{\text{VSHDN}} = V_{\text{IN}} = 5\text{V}$
I _{IL}	SHDN Input Current @ V _{IL}	-0.2	-0.05	0	μA	$\overline{\text{VSHDN}} = \text{GND}$

- Note**
- 1: V_R is the regulator output voltage setting.
 - 2: Dropout voltage is defined as the input to output differential at which the output voltage drops 2% below its nominal value measured at a 1V differential.
 - 3: Varies with type of pass transistor used. Numbers shown are for the test circuit of Figure 3-1.
 - 4: The product of I_{EXT} × V_{EXT} must be less than the maximum allowable power dissipation.

2.0 PIN DESCRIPTIONS

The descriptions of the pins are listed in Table 2-1.

TABLE 2-1: PIN FUNCTION TABLE

Pin No. (5-Pin SOT-23A)	Symbol	Description
1	GND	Ground terminal.
2	V_{IN}	Supply voltage input. Positive input voltage of 2.7V to 8.0V.
3	V_{OUT}	Regulator voltage sense input. Connects to the collector of the external PNP pass transistor.
4	EXT	Base Drive for the external PNP pass transistor.
5	SHDN	Shutdown Input. The device is enabled when $SHDN \leq V_{IL}$. The device enters a low power shutdown state when $SHDN \geq V_{IH}$. During shutdown, the output is disabled, and supply current falls to less than 1 μ A.

3.0 DETAILED DESCRIPTION

The TC57 series of precision low dropout regulator controllers use an external PNP transistor to accommodate a wide range of output currents. A series resistor (R_B) limits the maximum base current drawn from the PNP transistor. Limiting the base drive both determines the regulator's output current capability, as well as limits ground current when the device is operated in dropout. The PNP transistor's $V_{CE(SAT)}$ is the only factor limiting dropout voltage.

FIGURE 3-1: TEST CIRCUIT

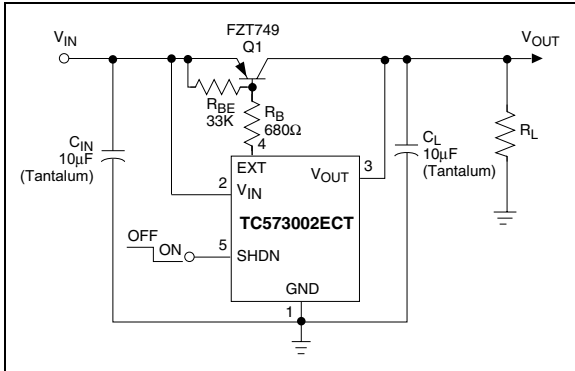

3.1 Transistor Selection

The PNP pass transistor must have satisfactory power dissipation, current gain, and collector current specifications to suit the application at hand. The maximum output current the circuit can deliver is influenced by h_{FE} . The highest guaranteed output current is given by:

EQUATION 3-1:

$$I_{LOAD(MAX)} = 25 \text{ mA} \times h_{FE(MIN)}$$

The transistor's actual power dissipation (PD) is equal to the maximum load current times the maximum input/output voltage differential, or:

EQUATION 3-2:

$$P_D \approx I_{LOAD(MAX)} \times (V_{IN(MAX)} - V_{OUT(MIN)})$$

The ideal transistor has a minimum h_{FE} of 100, and a $V_{CE(SAT)}$ of less than 0.6V at full output current. For example, the Zetex FZT749 has an h_{FE} of 170 at a collector current of 1A, and a guaranteed $V_{CE(SAT)}$ of 0.3V at a base current of 100mA. It is packaged in a SOT-223 and is recommended for use with the TC57. Other transistors are also suitable, depending on the required input and output voltages and output current (Table 3-1).

3.2 Base-Current Limiting Resistor

Base current limiting resistor R_B can be estimated using:

EQUATION 3-3:

$$R_B = \frac{h_{FE} (V_{IN} - V_{BE})}{I_{OUT}}$$

Where:

h_{FE} is the current gain of the pass transistor

V_{IN} is the input voltage (in volts)

V_{BE} is the base-emitter voltage at the desired output current (in volts)

I_{OUT} is the output current (in Amps)

For example, assume a desired continuous output current of 1.0A, an input voltage of 5V, and an FZT749 pass transistor. The FZT749 has a typical h_{FE} of 170, and a V_{BE} of 0.8V; both specified at a collector current of 1.0A. Substituting these values into the equation above results in an R_B value of 704Ω (closest standard value = 680Ω).

3.3 Pull-Up Resistor and Output Capacitor

A pull-up resistor (R_{BE} , installed between the base and emitter of the pass transistor) facilitates rapid turn-off of the pass transistor in the event of a sudden decrease in load (Figure 3-2). Recommended values for this resistor are between 20KΩ and 47KΩ. A Tantalum output capacitor of at least 10μF must be used to guarantee stability. Higher values decrease output noise and eliminate power-on overshoot, but extend power-up times. Table 3-1 lists several capacitor choices.

FIGURE 3-2: 3.3V, 1A REGULATOR USING 5V SUPPLY INPUT

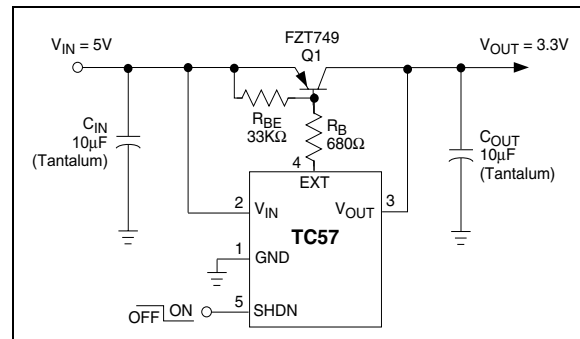

3.4 Input Capacitor

The addition of an input capacitor further reduces output noise, and negates the effects of power supply input impedance. A 10 μ F (min) Tantalum capacitor is recommended.

3.5 Shutdown Mode

The TC57 enters a low power shutdown mode when the shutdown input (SHDN) is high. During shutdown, the regulator is disabled, the output capacitor is discharged through the load, and supply current to the TC57 decreases to less than 1 μ A. Normal operation resumes when SHDN is brought low. If the shutdown mode is not used, SHDN should be tied to V_{IN} .

TABLE 3-1: COMPONENT SUPPLIERS

Device	Mounting Method	Manufacturer	Website
CAPACITORS			
267 Series	Surface Mount	Matsuo	http://www.matsuoelectronics.com
F95 Tantalum Series	Surface Mount	Nichicon	http://www.nichicon-us.com
595 Tantalum Series	Surface Mount	Sprague	http://www.vishay.com/brands/sprague
OS-CON Series	Through-Hole	Sanyo	http://www.sanyovideo.com
LXF Series	Through-Hole	United Chemi-Con	http://chemi-con.com
TRANSISTORS			
ZTX749	Through-Hole	Zetex	http://www.zetex.com
2N4403	Through-Hole	ON SEMI	http://www.onsemi.com/home
2N2907A	Through-Hole	ON SEMI	http://www.onsemi.com/home
FZT749	Surface Mount	Zetex	http://www.zetex.com

4.0 TYPICAL CHARACTERISTICS

Note: The graphs and tables provided following this note are a statistical summary based on a limited number of samples and are provided for informational purposes only. The performance characteristics listed herein are not tested or guaranteed. In some graphs or tables, the data presented may be outside the specified operating range (e.g., outside specified power supply range) and therefore outside the warranted range.

1. OUTPUT VOLTAGE vs. OUTPUT CURRENT

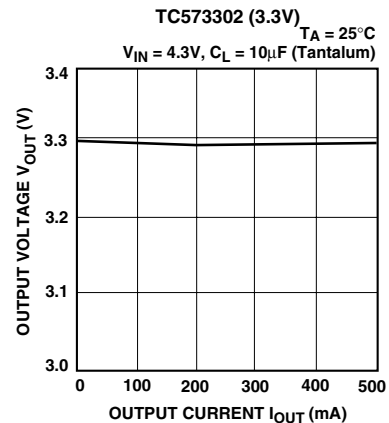
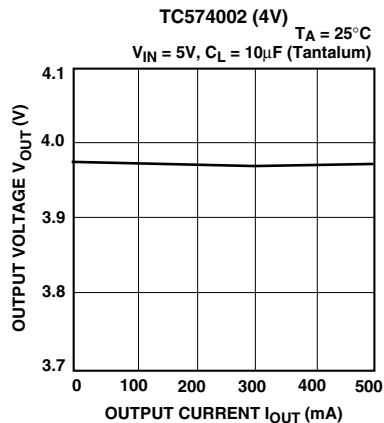
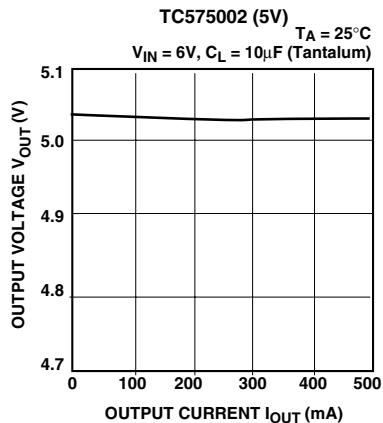

2. OUTPUT VOLTAGE vs. INPUT VOLTAGE

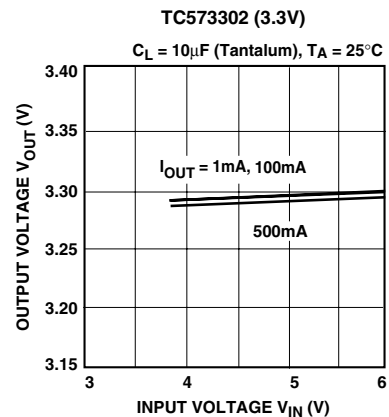
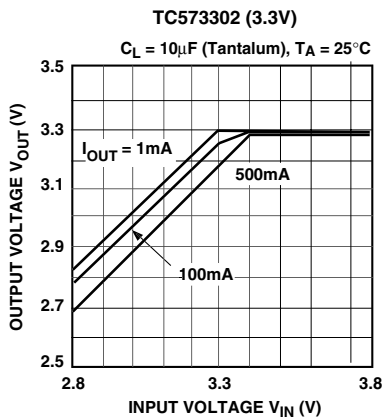
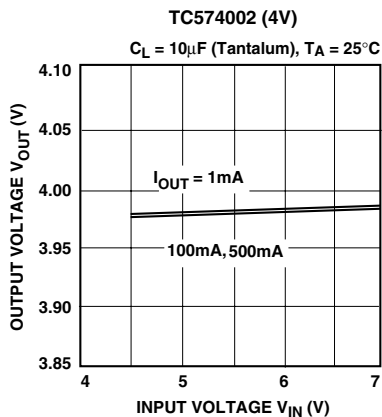
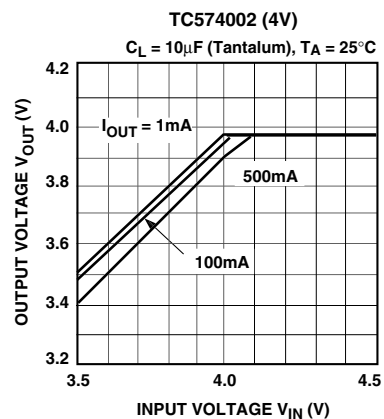
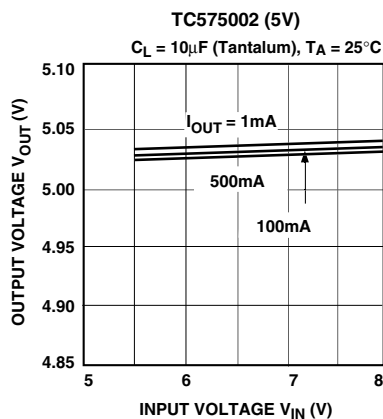
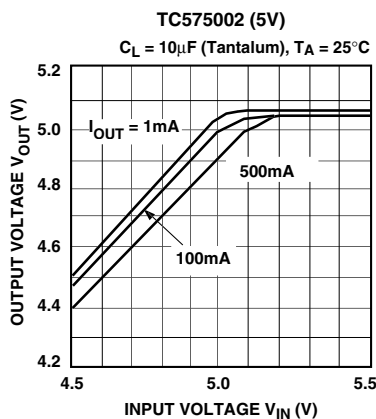

4.0 TYPICAL CHARACTERISTICS (CONTINUED)

3. DROPOUT VOLTAGE vs. OUTPUT CURRENT

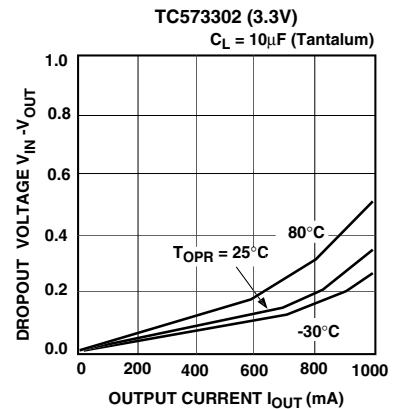
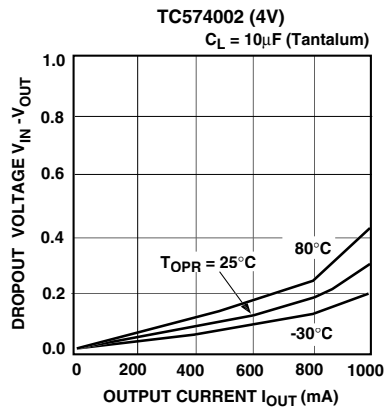
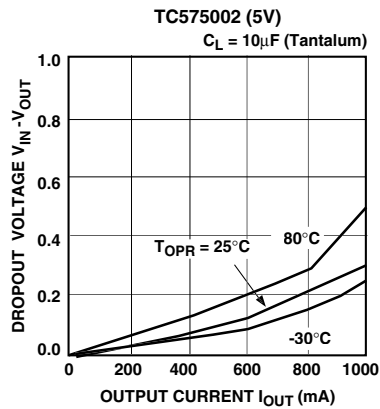

4. SUPPLY CURRENT vs. INPUT VOLTAGE

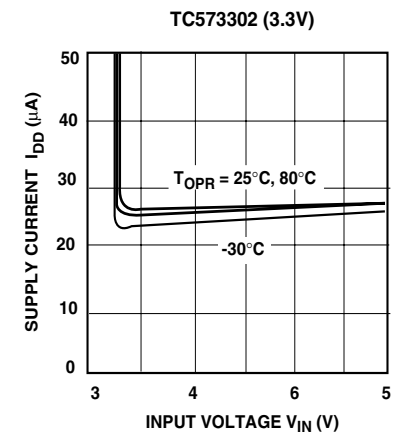
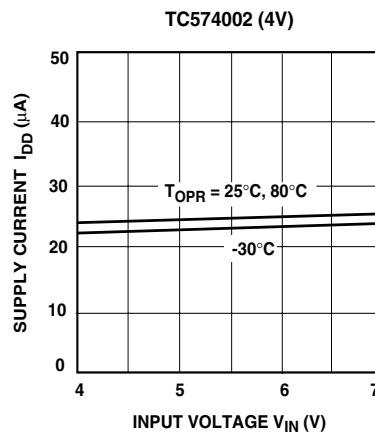
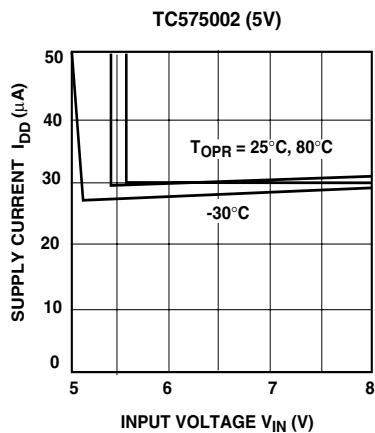

5. OUTPUT VOLTAGE vs. AMBIENT TEMPERATURE

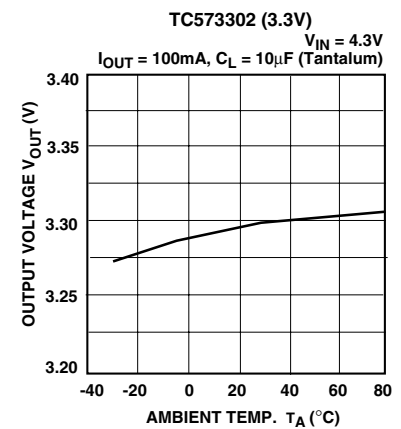
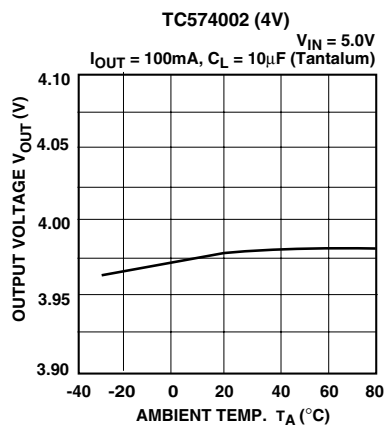
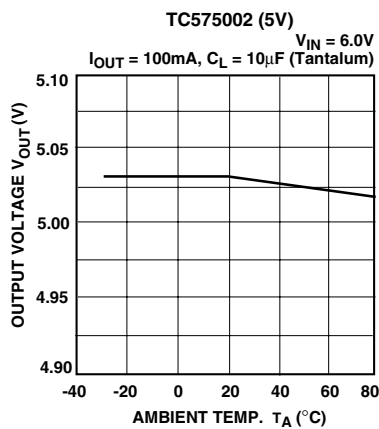

4.0 TYPICAL CHARACTERISTICS (CONTINUED)

6. SUPPLY CURRENT vs. AMBIENT TEMPERATURE

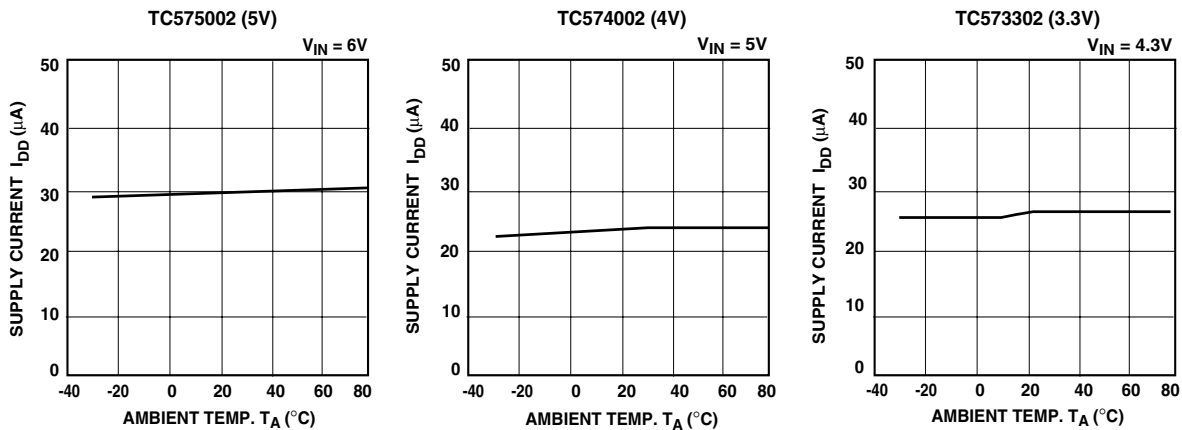

7. INPUT TRANSIENT RESPONSE

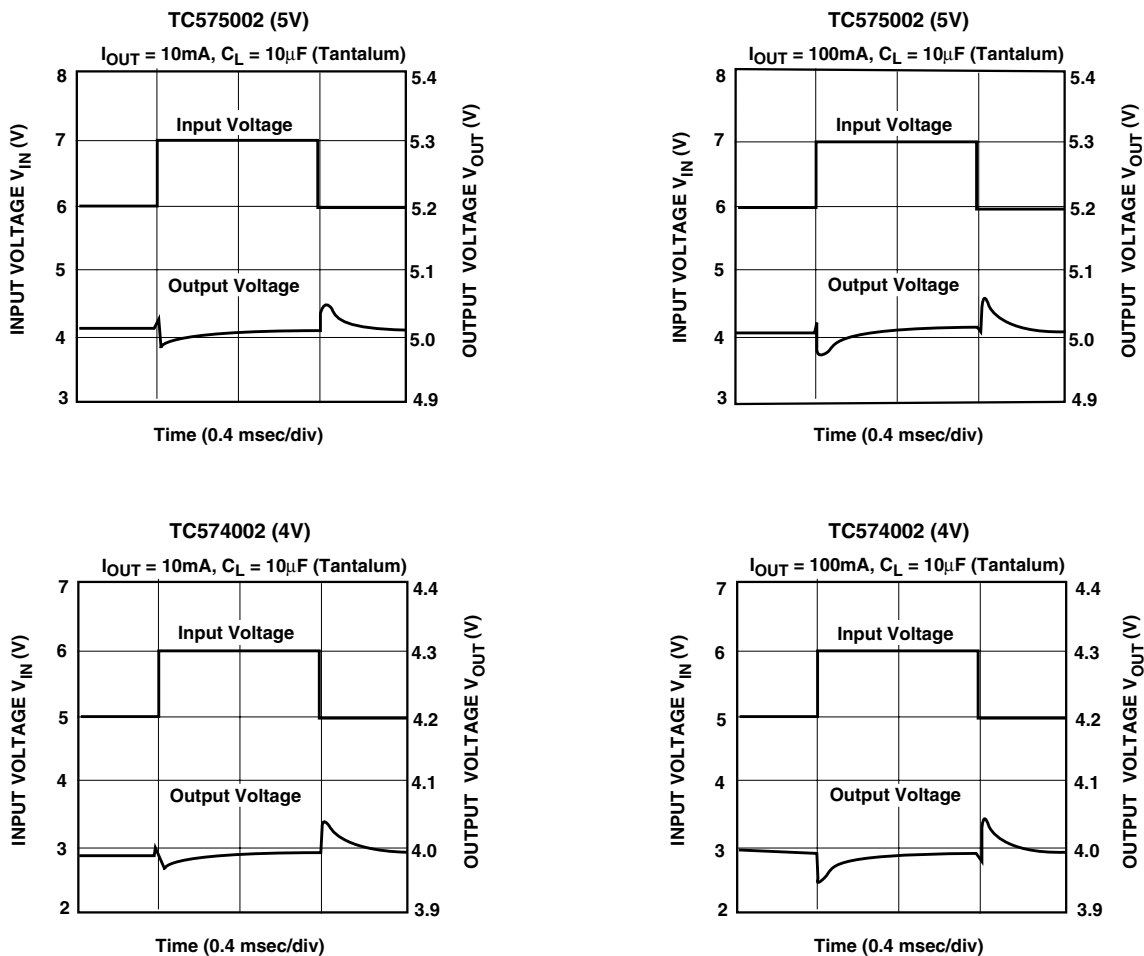

4.0 TYPICAL CHARACTERISTICS (CONTINUED)

7. INPUT TRANSIENT RESPONSE (CONT.)

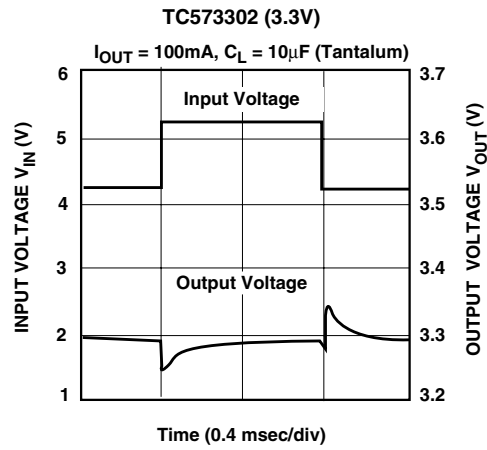
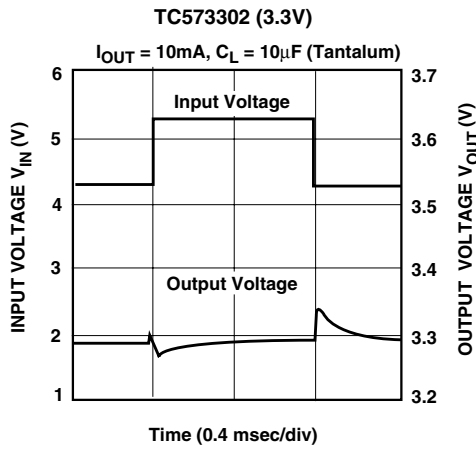

8. LOAD TRANSIENT RESPONSE

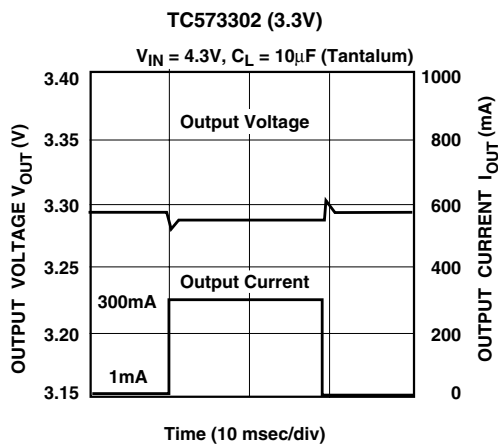
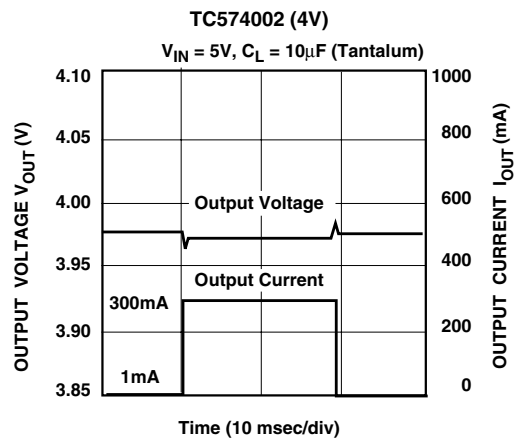
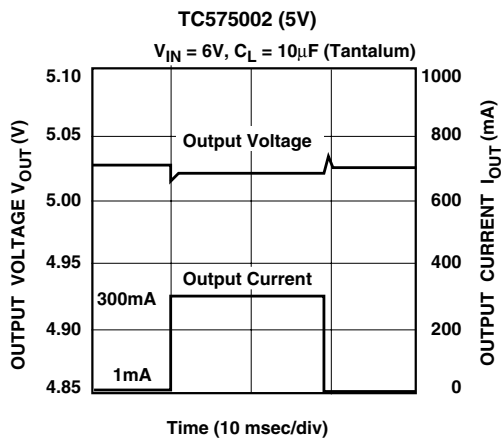

5.0 PACKAGING INFORMATION

5.1 Package Marking Information

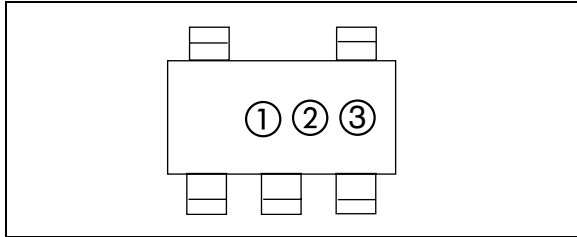

① represents integer part of output voltage

② represents first decimal of output voltage

Symbol	Voltage	Symbol	Voltage
0	.0	5	.5
1	.1	6	.6
2	.2	7	.7
3	.3	8	.8
4	.4	9	.9

③ represents production lot ID code

Symbol	Voltage
2	2.
3	3.
4	4.
5	5.
6	6.

5.2 Taping Form

Component Taping Orientation for 5-Pin SOT-23A (EIAJ SC-74A) Devices

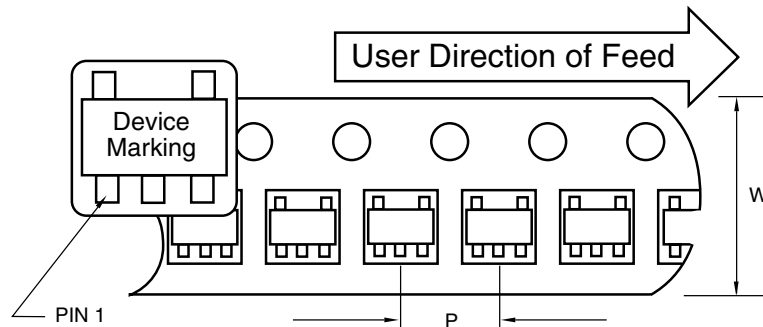

Standard Reel Component Orientation
TR Suffix Device
(Mark Right Side Up)

Carrier Tape, Number of Components Per Reel and Reel Size

Package	Carrier Width (W)	Pitch (P)	Part Per Full Reel	Reel Size
5-Pin SOT-23A	8 mm	4 mm	3000	7 in

5.3 Package Dimensions

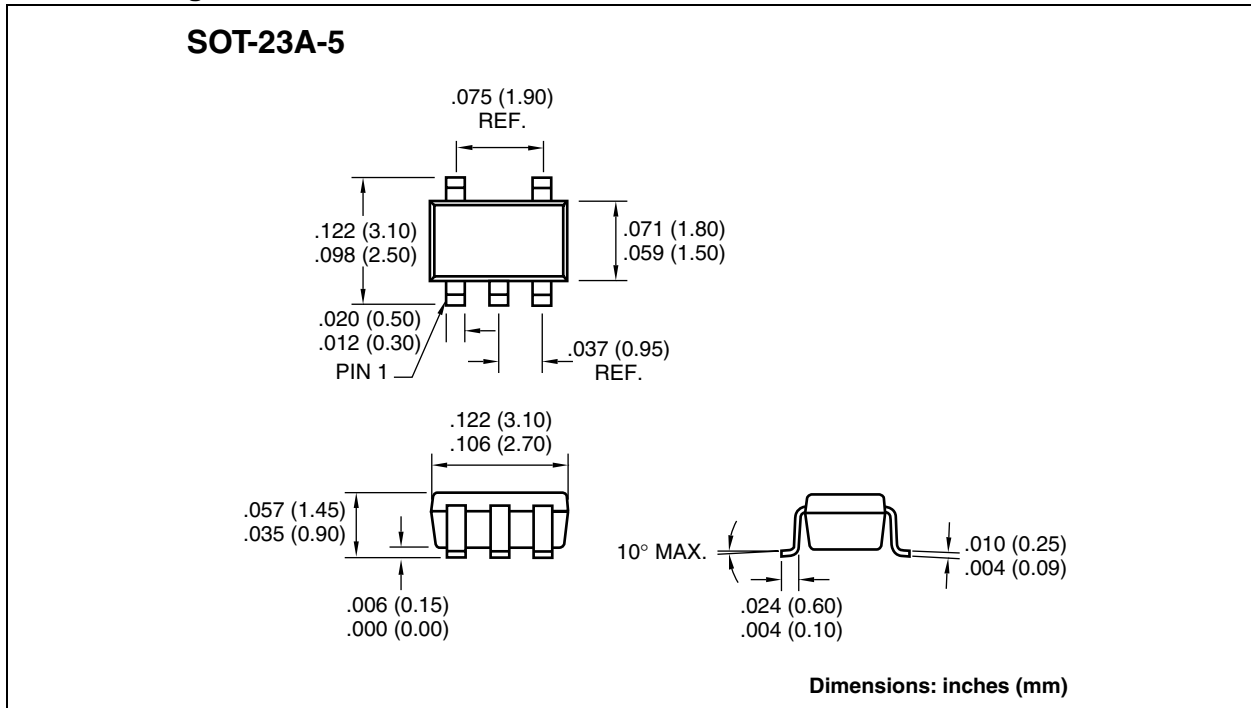

TC57

NOTES:

PRODUCT IDENTIFICATION SYSTEM

To order or obtain information, e.g., on pricing or delivery, refer to the factory or the listed sales office.

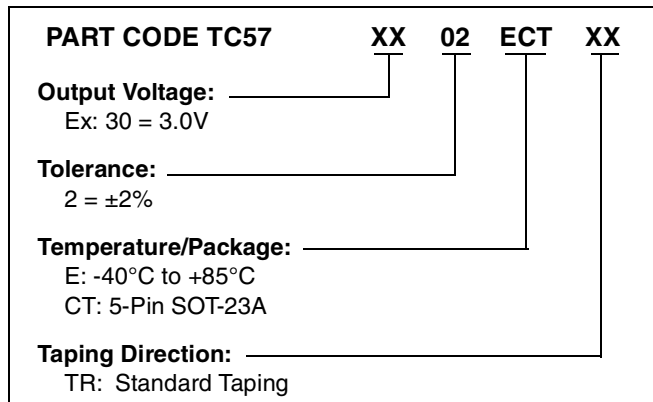

Sales and Support

Data Sheets

Products supported by a preliminary Data Sheet may have an errata sheet describing minor operational differences and recommended workarounds. To determine if an errata sheet exists for a particular device, please contact one of the following:

1. Your local Microchip sales office
2. The Microchip Corporate Literature Center U.S. FAX: (480) 792-7277
3. The Microchip Worldwide Site (www.microchip.com)

Please specify which device, revision of silicon and Data Sheet (include Literature #) you are using.

New Customer Notification System

Register on our web site (www.microchip.com/cn) to receive the most current information on our products.

TC57

NOTES:

Information contained in this publication regarding device applications and the like is intended through suggestion only and may be superseded by updates. It is your responsibility to ensure that your application meets with your specifications. No representation or warranty is given and no liability is assumed by Microchip Technology Incorporated with respect to the accuracy or use of such information, or infringement of patents or other intellectual property rights arising from such use or otherwise. Use of Microchip's products as critical components in life support systems is not authorized except with express written approval by Microchip. No licenses are conveyed, implicitly or otherwise, under any intellectual property rights.

Trademarks

The Microchip name and logo, the Microchip logo, FilterLab, KEELOQ, microID, MPLAB, PIC, PICmicro, PICMASTER, PICSTART, PRO MATE, SEEVAL and The Embedded Control Solutions Company are registered trademarks of Microchip Technology Incorporated in the U.S.A. and other countries.

dsPIC, ECONOMONITOR, FanSense, FlexROM, fuzzyLAB, In-Circuit Serial Programming, ICSP, ICEPIC, microPort, Migratable Memory, MPASM, MPLIB, MPLINK, MPSIM, MXDEV, MXLAB, PICC, PICDEM, PICDEM.net, rPIC, Select Mode and Total Endurance are trademarks of Microchip Technology Incorporated in the U.S.A.

Serialized Quick Turn Programming (SQTP) is a service mark of Microchip Technology Incorporated in the U.S.A.

All other trademarks mentioned herein are property of their respective companies.

© 2002, Microchip Technology Incorporated, Printed in the U.S.A., All Rights Reserved.

 Printed on recycled paper.



Microchip received QS-9000 quality system certification for its worldwide headquarters, design and wafer fabrication facilities in Chandler and Tempe, Arizona in July 1999 and Mountain View, California in March 2002. The Company's quality system processes and procedures are QS-9000 compliant for its PICmicro® 8-bit MCUs, KEELOQ® code hopping devices, Serial EEPROMs, microperipherals, non-volatile memory and analog products. In addition, Microchip's quality system for the design and manufacture of development systems is ISO 9001 certified.



MICROCHIP

WORLDWIDE SALES AND SERVICE

AMERICAS

Corporate Office

2355 West Chandler Blvd.
Chandler, AZ 85224-6199
Tel: 480-792-7200 Fax: 480-792-7277
Technical Support: 480-792-7627
Web Address: <http://www.microchip.com>

Rocky Mountain

2355 West Chandler Blvd.
Chandler, AZ 85224-6199
Tel: 480-792-7966 Fax: 480-792-7456

Atlanta

500 Sugar Mill Road, Suite 200B
Atlanta, GA 30350
Tel: 770-640-0034 Fax: 770-640-0307

Boston

2 Lan Drive, Suite 120
Westford, MA 01886
Tel: 978-692-3848 Fax: 978-692-3821

Chicago

333 Pierce Road, Suite 180
Itasca, IL 60143
Tel: 630-285-0071 Fax: 630-285-0075

Dallas

4570 Westgrove Drive, Suite 160
Addison, TX 75001
Tel: 972-818-7423 Fax: 972-818-2924

Detroit

Tri-Atria Office Building
32255 Northwestern Highway, Suite 190
Farmington Hills, MI 48334
Tel: 248-538-2250 Fax: 248-538-2260

Kokomo

2767 S. Albright Road
Kokomo, Indiana 46902
Tel: 765-864-8360 Fax: 765-864-8387

Los Angeles

18201 Von Karman, Suite 1090
Irvine, CA 92612
Tel: 949-263-1888 Fax: 949-263-1338

New York

150 Motor Parkway, Suite 202
Hauppauge, NY 11788
Tel: 631-273-5305 Fax: 631-273-5335

San Jose

Microchip Technology Inc.
2107 North First Street, Suite 590
San Jose, CA 95131
Tel: 408-436-7950 Fax: 408-436-7955

Toronto

6285 Northam Drive, Suite 108
Mississauga, Ontario L4V 1X5, Canada
Tel: 905-673-0699 Fax: 905-673-6509

ASIA/PACIFIC

Australia

Microchip Technology Australia Pty Ltd
Suite 22, 41 Rawson Street
Epping 2121, NSW
Australia
Tel: 61-2-9868-6733 Fax: 61-2-9868-6755

China - Beijing

Microchip Technology Consulting (Shanghai)
Co., Ltd., Beijing Liaison Office
Unit 915
Bei Hai Wan Tai Bldg.
No. 6 Chaoyangmen Beidajie
Beijing, 100027, No. China
Tel: 86-10-85282100 Fax: 86-10-85282104

China - Chengdu

Microchip Technology Consulting (Shanghai)
Co., Ltd., Chengdu Liaison Office
Rm. 2401, 24th Floor,
Ming Xing Financial Tower
No. 88 TIDU Street
Chengdu 610016, China
Tel: 86-28-86766200 Fax: 86-28-86766599

China - Fuzhou

Microchip Technology Consulting (Shanghai)
Co., Ltd., Fuzhou Liaison Office
Unit 28F, World Trade Plaza
No. 71 Wusi Road
Fuzhou 350001, China
Tel: 86-591-7503506 Fax: 86-591-7503521

China - Shanghai

Microchip Technology Consulting (Shanghai)
Co., Ltd.
Room 701, Bldg. B
Far East International Plaza
No. 317 Xian Xia Road
Shanghai, 200051
Tel: 86-21-6275-5700 Fax: 86-21-6275-5060

China - Shenzhen

Microchip Technology Consulting (Shanghai)
Co., Ltd., Shenzhen Liaison Office
Rm. 1315, 13/F, Shenzhen Kerry Centre,
Renminnan Lu
Shenzhen 518001, China
Tel: 86-755-2350361 Fax: 86-755-2366086

China - Hong Kong SAR

Microchip Technology Hongkong Ltd.
Unit 901-6, Tower 2, Metroplaza
223 Hing Fong Road
Kwai Fong, N.T., Hong Kong
Tel: 852-2401-1200 Fax: 852-2401-3431

India

Microchip Technology Inc.
India Liaison Office
Divyasree Chambers
1 Floor, Wing A (A3/A4)
No. 11, O'Shaugnessey Road
Bangalore, 560 025, India
Tel: 91-80-2290061 Fax: 91-80-2290062

Japan

Microchip Technology Japan K.K.
Benex S-1 6F
3-18-20, Shinyokohama
Kohoku-Ku, Yokohama-shi
Kanagawa, 222-0033, Japan
Tel: 81-45-471-6166 Fax: 81-45-471-6122

Korea

Microchip Technology Korea
168-1, Youngbo Bldg. 3 Floor
Samsung-Dong, Kangnam-Ku
Seoul, Korea 135-882
Tel: 82-2-554-7200 Fax: 82-2-558-5934

Singapore

Microchip Technology Singapore Pte Ltd.
200 Middle Road
#07-02 Prime Centre
Singapore, 188980
Tel: 65-6334-8870 Fax: 65-6334-8850

Taiwan

Microchip Technology Taiwan
11F-3, No. 207
Tung Hua North Road
Taipei, 105, Taiwan
Tel: 886-2-2717-7175 Fax: 886-2-2545-0139

EUROPE

Denmark

Microchip Technology Nordic ApS
Regus Business Centre
Lautrup høj 1-3
Ballerup DK-2750 Denmark
Tel: 45 4420 9895 Fax: 45 4420 9910

France

Microchip Technology SARL
Parc d'Activite du Moulin de Massy
43 Rue du Saule Trapu
Batiment A - 1er Etage
91300 Massy, France
Tel: 33-1-69-53-63-20 Fax: 33-1-69-30-90-79

Germany

Microchip Technology GmbH
Gustav-Heinemann Ring 125
D-81739 Munich, Germany
Tel: 49-89-627-144 0 Fax: 49-89-627-144-44

Italy

Microchip Technology SRL
Centro Direzionale Colleoni
Palazzo Taurus 1 V. Le Colleoni 1
20041 Agrate Brianza
Milan, Italy
Tel: 39-039-65791-1 Fax: 39-039-6899883

United Kingdom

Microchip Ltd.
505 Eskdale Road
Winnersh Triangle
Wokingham
Berkshire, England RG41 5TU
Tel: 44 118 921 5869 Fax: 44-118 921-5820

05/01/02

